

Frezing in het kozijn voor sluitkom automatische schoot

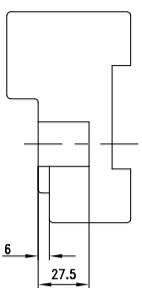

Bijzet slotkast met automatische schoot

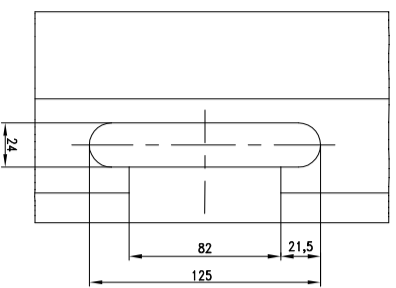
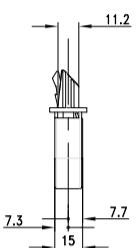
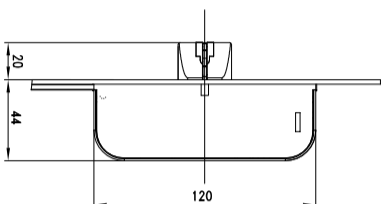

Frezing voor bijzet slotkast voor automatische schoot

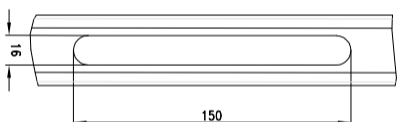
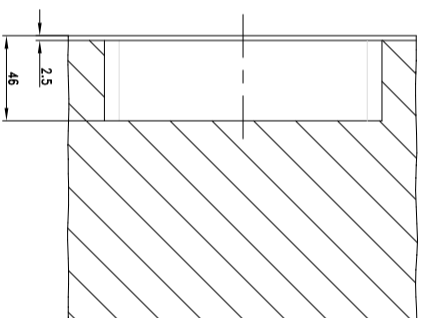

Automatische schoot

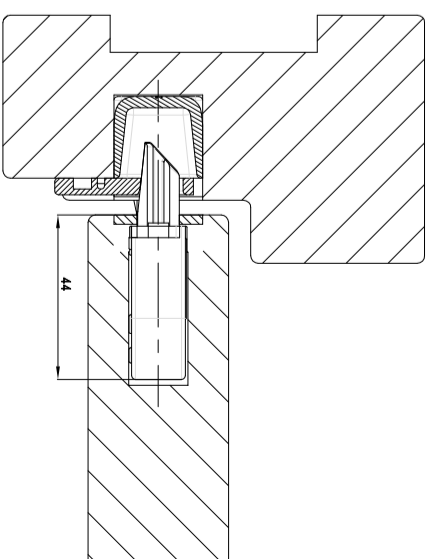

Frezing in kozijn voor sluitkom hoofdslot

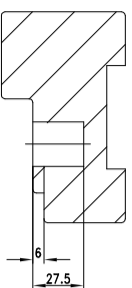
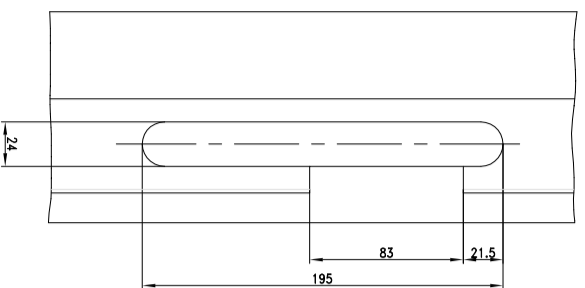

Maatvoering hoofdslotkast

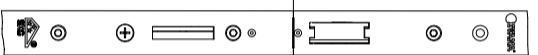
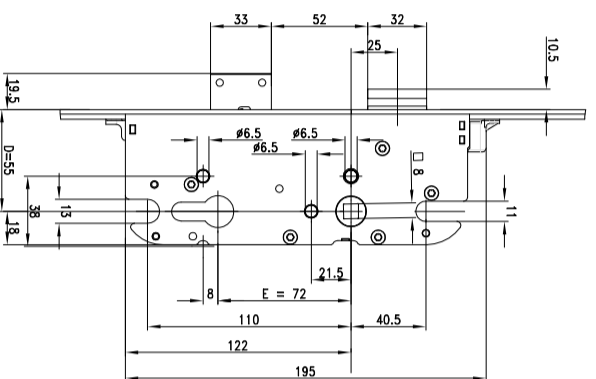

Krukgathoogte 1050mm

Frezing voor de Hoofdslotkast

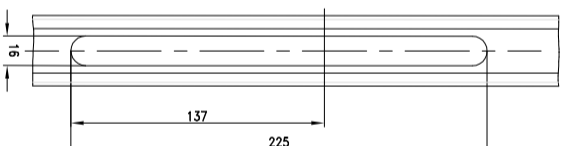
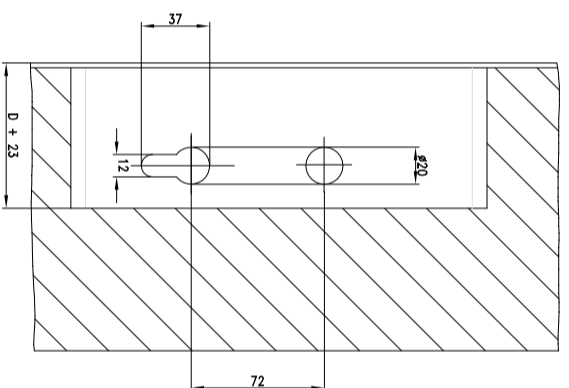

Doorsnede deur en kozijn

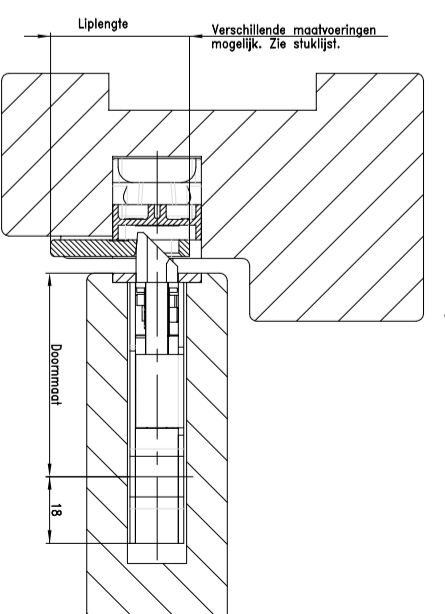

Y

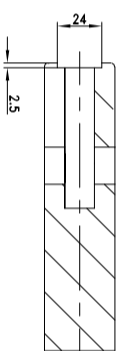
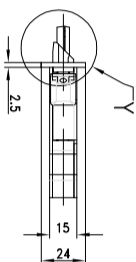
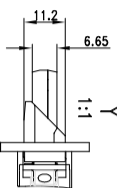

Description

IVANA MEERPUNTSLUITINGEN AUTOMATIC



Bestel nr.	In Work	Maakt	1
Werk nr.	Melding	1	X
Datum	01.05.2018	MM	
Approved for			
Productcode			
HL06001			
Blad	1		
			2/2